

Serie7[®] – dørvrider og beslag



Dørbeslag
dormakaba Serie7[®]
– et trygt valg

dormakaba 

dormakaba Serie7[®]

er vår mest
omfattende serie
vridere og beslag

Materialvalg og overflatebehandling

Alle vridere i dormakaba Serie7[®] er laget av zamak og belagt med høykvalitets overflatebehandlinger i fire forskjellige farger/overflatefinish.



Forkrommet
(CRP)



Forkrommet Matt
(CRS)



Silver matt
(CRM)



Messing Matt
(MB-PVD)

Spørsmål? Kontakt din dormakaba-representant.

Serie7° og Serie8° er våre mest holdbare dørbeslag noensinne. Da vi utviklet seriene hadde vi en klar visjon: å møte markedets krav, uten noen kompromisser. Resultatet ble stilig utformede vridere og beslag for innendørs og utendørs bruk, bygget for tøff og hyppig bruk hver dag.

Serie7° – vridere og beslag for innendørs bruk

dormakaba Serie7° er en omfattende serie med vridere og beslag i høy kvalitet, utviklet spesielt for å møte markedets krav til dører for innendørs bruk. Med Serie7° tilbyr dormakaba vridere og beslag med ett moderne design som går hånd i hånd med dormakabas andre produktserier og passer samtidig lett inn ulikt interiør og for ulike behov.

Våre beslag og vridere er tilpasset skandinavisk standard og er basert på kvalitetsvridere i zamak som klarer 200 000 åpninger i henhold til tester mot EN 1906, klasse 4.

dormakaba Serie7° og utendørsserien Serie8° kan enkelt kombineres uten at det ensartede estetiske inntrykket endres. Et design, mange muligheter.

Serie7° i korte trekk:

- Bredt sortiment med sammenhengende design
- Vridere og beslag produsert i zamak, med flere dekorative ytterbehandlinger
- Oppfyller de tøffeste kravene til beslagstandard EN 1906, 200 000 åpningssykluser, klasse 4
- Produktene oppfyller EUs nikkeldirektiv 94/27/EG

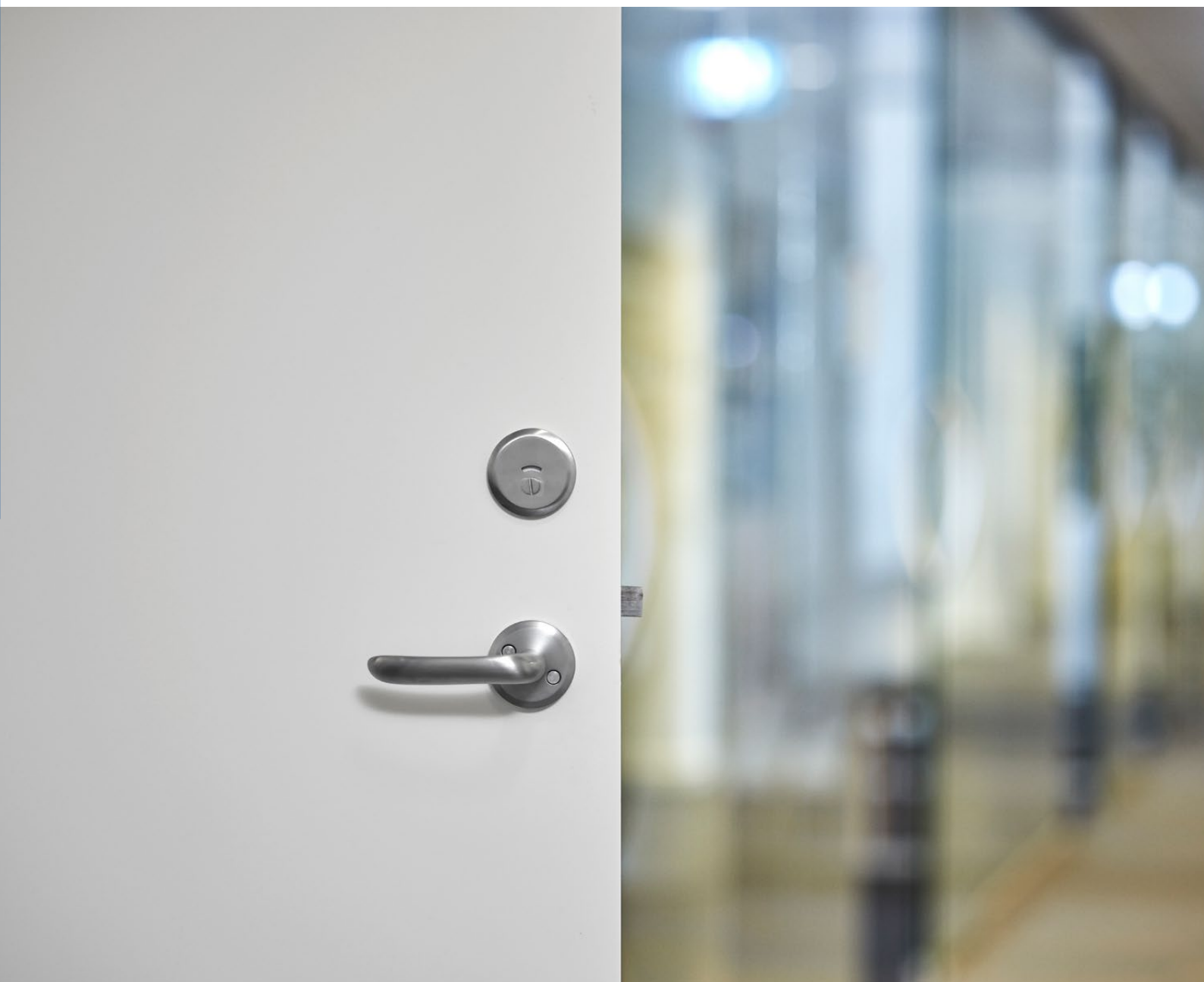

Dørvidere

Serie7^o inneholder dormakabas bredeste utvalg av stilige kvalitetsvridere. Alle vridere er tilgjengelige med eller uten retur fjær for å passe alle dørtykkelser mellom 35 og 95 mm innendørs – med låsehus av skandinavisk standard, 50 eller 70 mm backset. Alle vridere i serien er laget av zamak og belagt med høykvalitets overflatebehandlinger. Festes med gjennomgående M5 skruer

- EN 1906: 200 000 sykluser, klasse 4
- Samsvarer med EUs nikkeldirektiv

Vridere med retur fjær

Dobbeltvirkende retur fjær for lang levetid.

- Egnet til dører med høy åpningshyppighet
- Gjennomgående skruefeste M5
- Til dørtykkelser på 38–95 mm
- Egnet for skandinavisk låsekasser med 50 mm eller 70 mm backset.

Dørvidere DH 7020

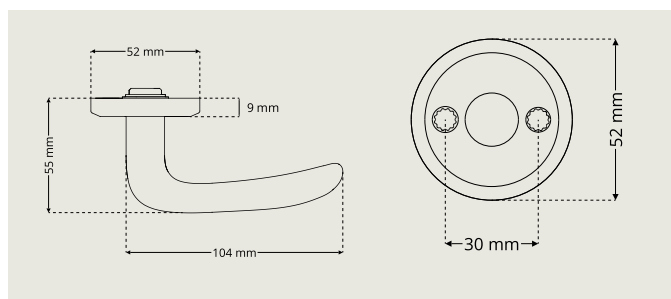

Dørvidere DH 7021

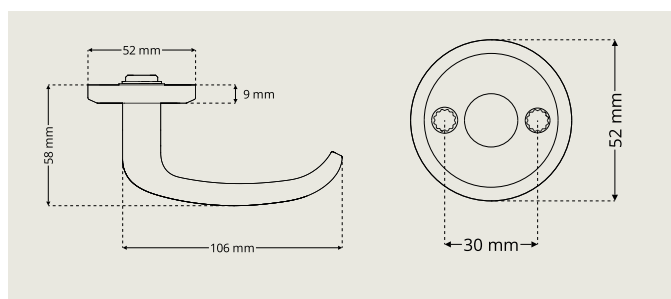

Dørvidere DH 7022

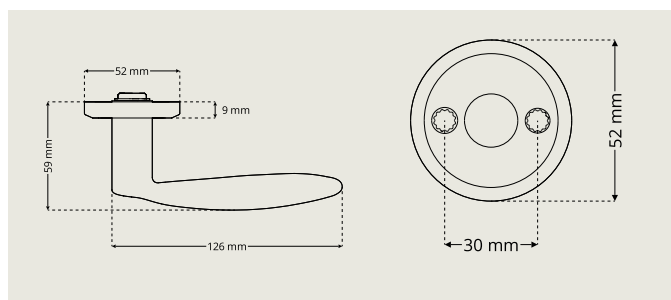

Dørvrider DH 7023

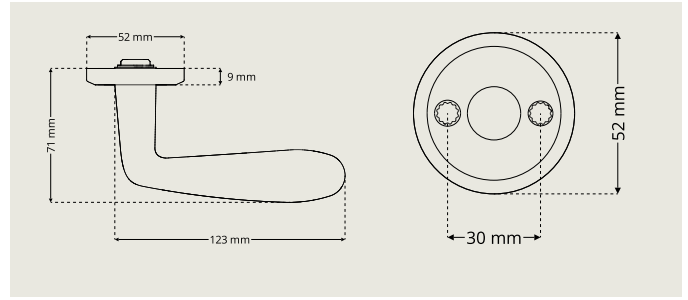

Dørvrider DH 7024

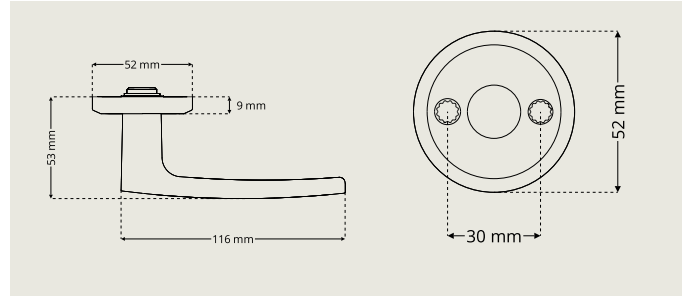

Dørvrider DH 7027

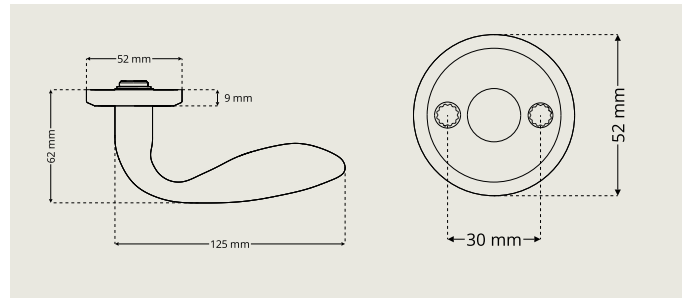

Vridere uten retur fjær

Til dører med middels til lav åpningshyppighet.

- Gjennomgående skruefeste M5
- Til dørtykkelser på 38–95 mm

Dørvider DH 7010

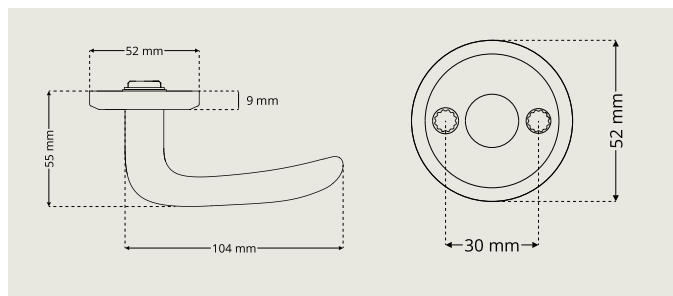

Dørvider DH 7011

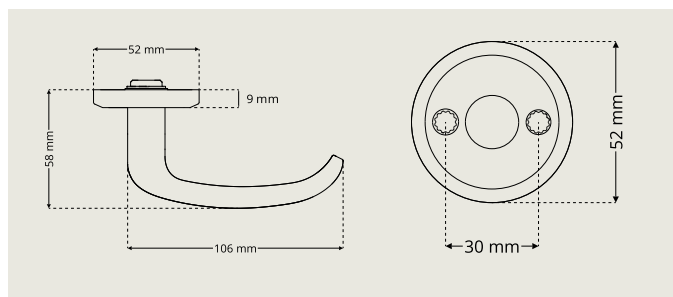

Dørvider DH 7013

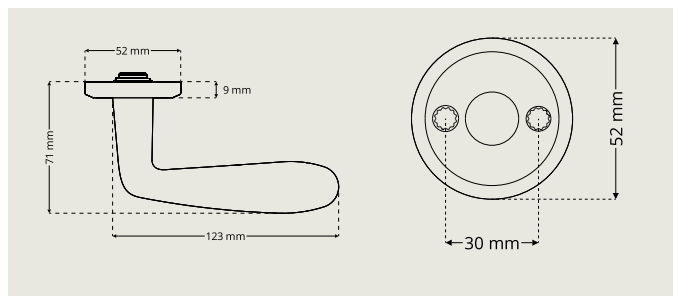

Dørvider DH 7014

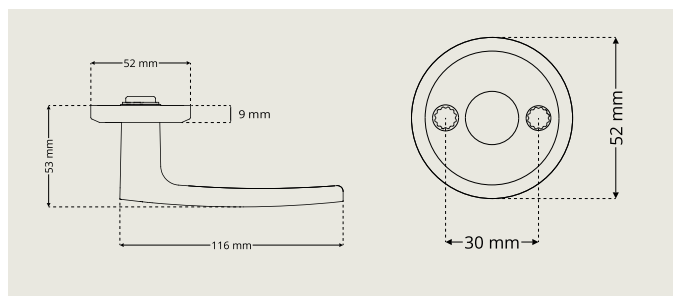

Dørvrider DH 7015

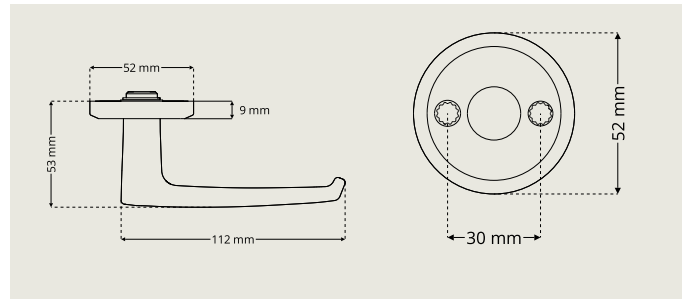

Dørvrider DH 7016

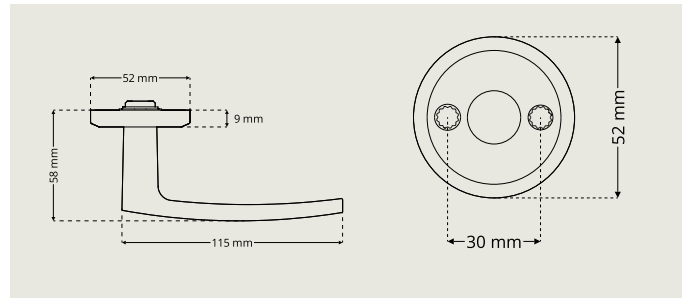

Dørvrider DH 7017

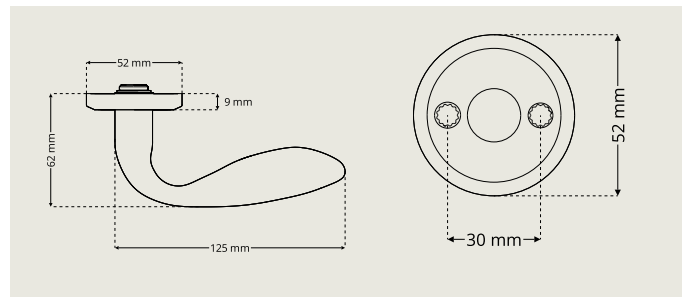

Knappvrider

Serie7[®] inneholder grepvennlige knappvrider og vriderskilt for låskasser av skandinavisk standard i 50 og 70 backset-design. Serien inkluderer også spesialdesignet grepsvennlig knappvrider for enkel tilgjengelighet.

– Samsvarer med EUs nikkeldirektiv

Knappvrider

Knapp-dekkskilt DP 7704

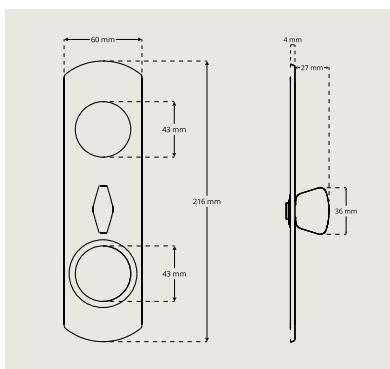

Knapp-dekkskilt DP 7709

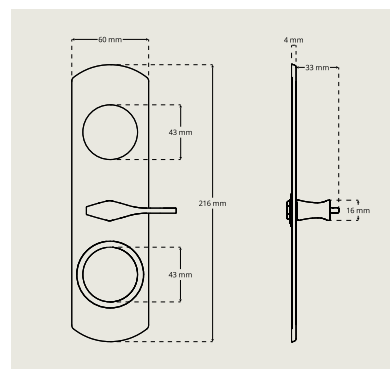

Knapp for enkel tilgjengelighet

Dekkskilt DP 7774

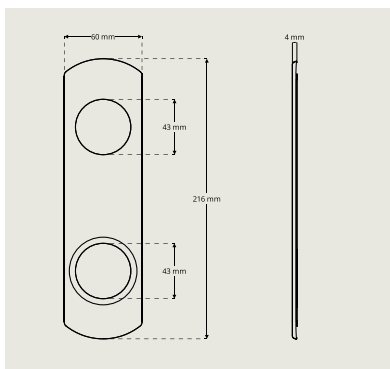

Knappskilt DA 7200

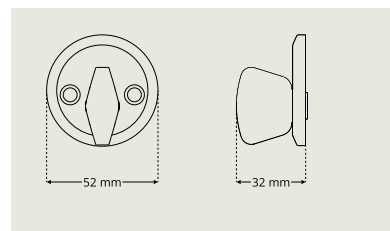

Knappskilt DA 7209

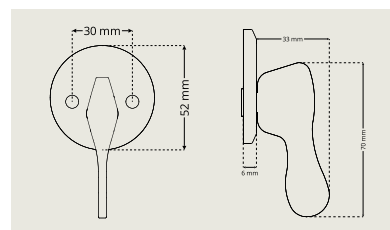

Knapp for enkel tilgjengelighet

Sylinderbeslag

Serie7^o inneholder et bredt utvalg sylinder-tilbehør av ulike typer i en rekke ulike høyder. Passer alle innendørs dører med låskasser av skandinavisk standard med 50 eller 70 mm backset.

– Samsvarer med EUs nikkeldirektiv

Sylinderskilter For ovalsylander

Sylinderskilt DR 7320

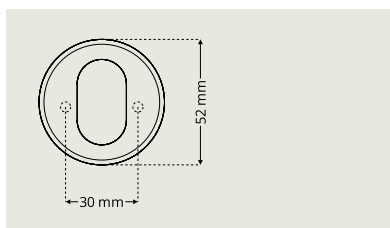

Sylinderskilt DR 7320 er tilgjengelig i høyder 6-21 mm. Ikke Dynamic.

Sylinderskilt DR 7330

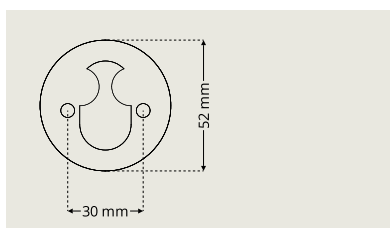

Sylinderskilt DR 7330 er tilgjengelig i høyder 6-21 mm. Ikke Dynamic.

Sylinderskilt DR 7340

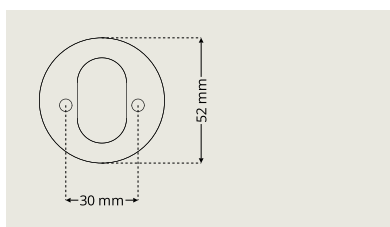

Sylinderskilt DR 7340 er tilgjengelig i høyder 6-21 mm. Ikke Dynamic.

Sylinderskilter For ovalsylander Dynamic

Sylinderskilt Dynamic DR D7320

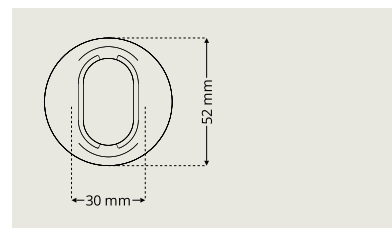

Sylinderskilt Dynamic DR D7320: sylinderhøyde 8-19 mm i samme ring.

Sylinderskilt Dynamic DR D7330

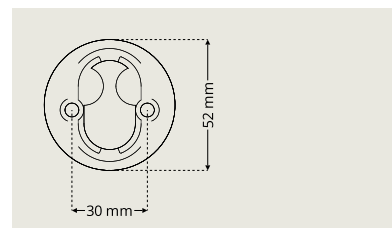

Sylinderskilt Dynamic DR D7330: sylinderhøyde 8-19 mm i samme ring.

Sylinderskilt Dynamic DR D7340

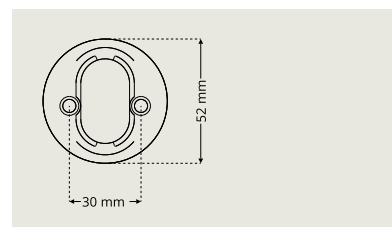

Sylinderskilt Dynamic DR D7340: sylinderhøyde 8-19 mm i samme ring.

Sylinderskilter For rundsylander

Sylinderskilt rund DR R7352

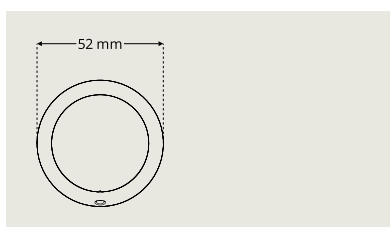

Sylinderskilt DR R7352 er tilgjengelig i høyder 8-21 mm

Sylinderskilt rund DR R7354

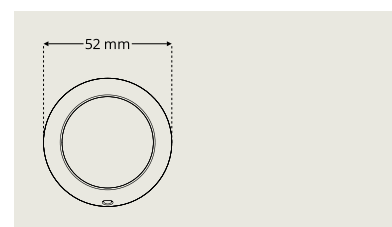

Sylinderskilt med gjenger: Sylinderskilt DR R7354 er tilgjengelig i høyder 8-21 mm

Distanseringer For å utvide sylinderskilter

Distansering DR 65/100

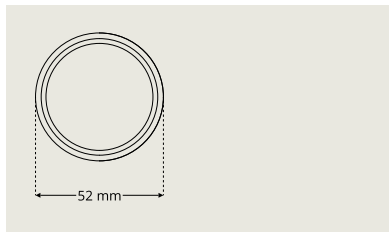

Distansering DR 65 (høyde 6,5 mm) er også tilgjengelig i 10 mm høyde (distansering DR 100).

Annet cylindertilbehør

Nøkkelkilt DA 7190

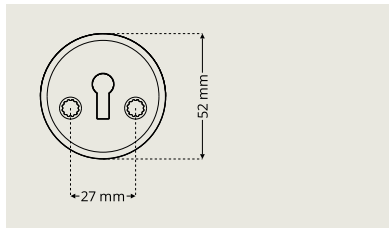

Nøkkelkilt DA 7190 for innvendige dørlåser type DL 112

Kåpe DA 7395

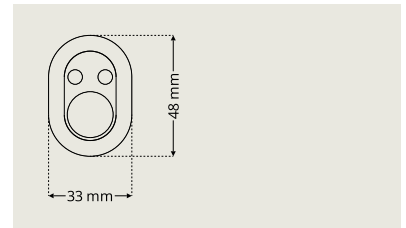

Blindskilt DA 7101

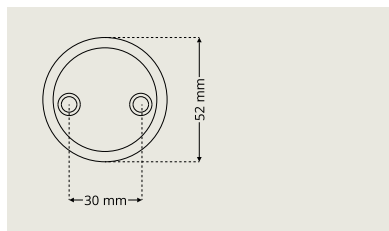

Distansering DA 7395

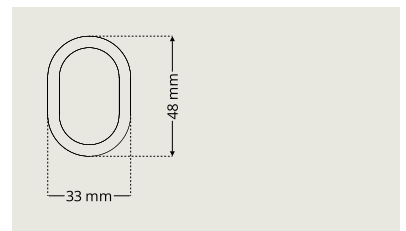

Distansering DA 7395-5 (høyde 5 mm) er også tilgjengelig i 10 mm høyde (distansering DA 7395-10)

Blindskilt DA 7102

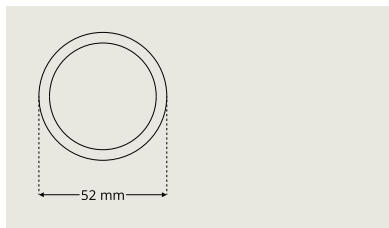

Kåpeskilt DA 7394

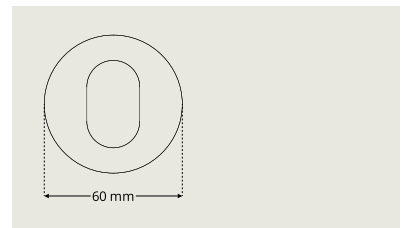

Kåpeskilt DA 7394 brukes sammen med kåpe DA 7395

Blindskilt DA 7100

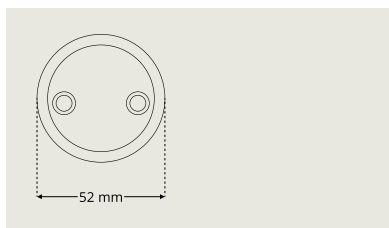

Tilbehørssett

DAK 7200/D7320

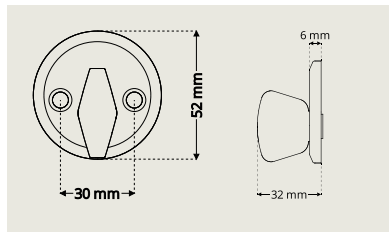

Sylinderringhøyde 8-19 mm i samme ring

DAK 7330/D7320

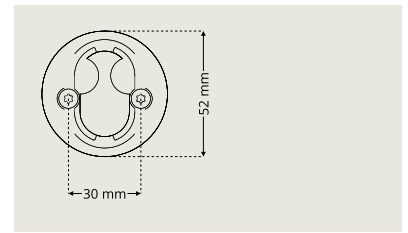

Sylinderringhøyde 8-19 mm i samme ring

DAK 7101/D7320

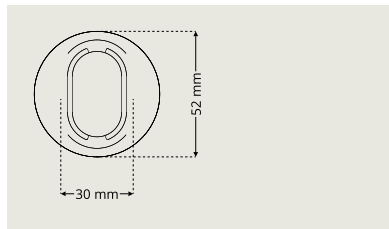

Sylinderringhøyde 8-19 mm i samme ring

DAK 7340/D7320

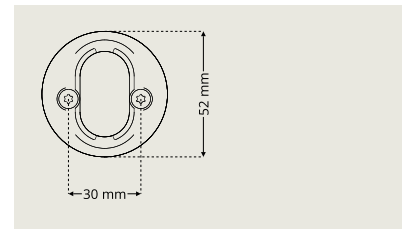

Sylinderringhøyde 8-19 mm i samme ring

DAK D7330/7102

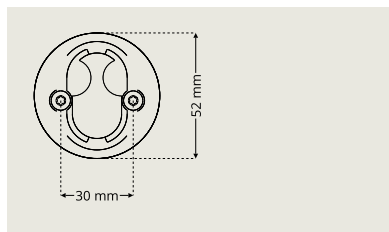

Sylinderringhøyde 8-19 mm i samme ring

Toalettbeslag

Toaletttilbeslag i dormakaba Serie7® følger seriens moderne design. Utvalget inkluderer toaletttilbehør med grepsvennlige knappvridere, samt spesialdesignede vridere for enkel tilgjengelighet.

– Samsvarer med EUs nikkeldirektiv

Toalettbeslag For innendørs låskasser av skandinavisk standard i 50 og 70 backset-design

Toalettskilt DI 7261-1/-2

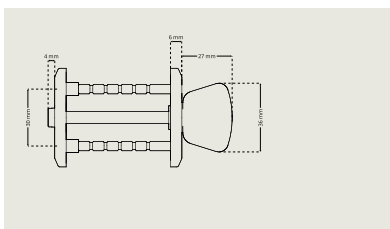

Tilgjengelig i to lengder – DI 7261-1 for dørtykkelse 35-55 mm, DI 7261-2 for dørtykkelse 55-75 mm

Toalettskilt DI 7269-1/-2

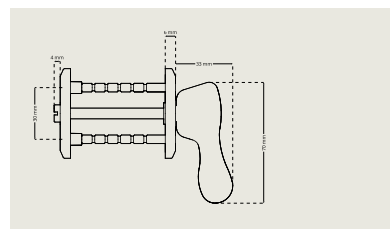

Tilgjengelig i to lengder – DI 7269-1 for dørtykkelse 35-55 mm, DI 7269-2 for dørtykkelse 55-75 mm

Toalettskilt DI 7281-1/2

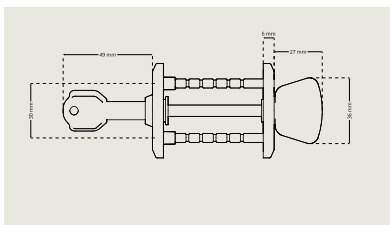

Tilgjengelig i to lengder – DI 7281-1 for dørtykkelse 35-55 mm, DI 7281-2 for dørtykkelse 55-75 mm

Toalettskilt DI 7289-1/2

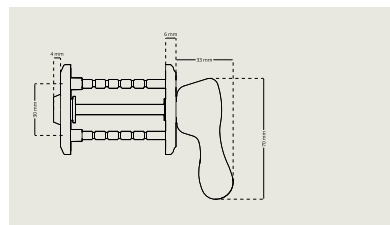

Tilgjengelig i to lengder – DI 7289-1 for dørtykkelse 35-55 mm, DI 7289-2 for dørtykkelse 55-75 mm

Panikknøkkel DI 7281/DI7289

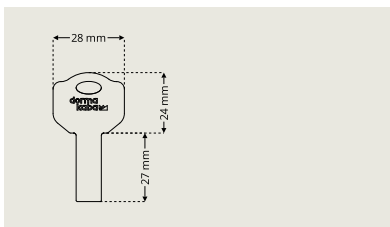

Toalettbeslag For innendørs lås

Toalettskilt DI 7271

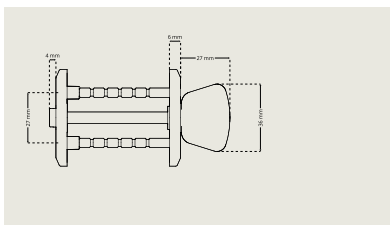

Toalettskilt DI 7271 – for innerelås type DL 112, dørtykkelse 35-55 mm

Toalettskilt DI 7279

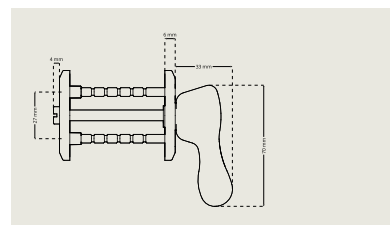

Toalettskilt DI 7279 – for innerelås type DL 112, dørtykkelse 35-55 mm

Komplementære produkter

Motfjæret knappsyndere

Knappsyndere med fjærende funksjon for montering på låskasser i skandinavisk standard med 360° nøkkelvridning. Sortimentet inkluderer ovale knappsyndere som passer til for eksempel smale profillåser og runde knappsyndere for skandinaviske låskasser med 50 eller 70 mm backset.

– Samsvarer med EUs nikkeldirektiv

**Knappsynder
KC2541SL**

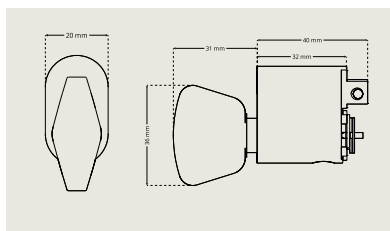

**Knappsynder
KC2572SL**

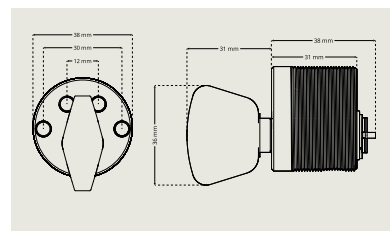

**Knappsynder
KC2542SL**

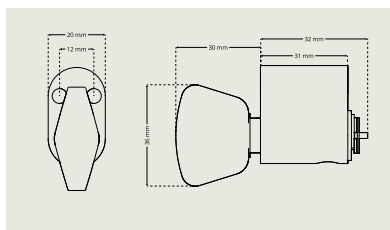

**Knappsynder
KC2573SL**

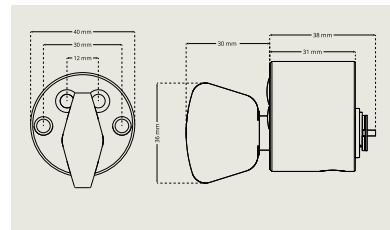

**Knappsynder
KC2549SL**

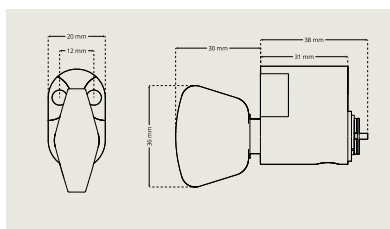

dormakaba Smart dørbeslag

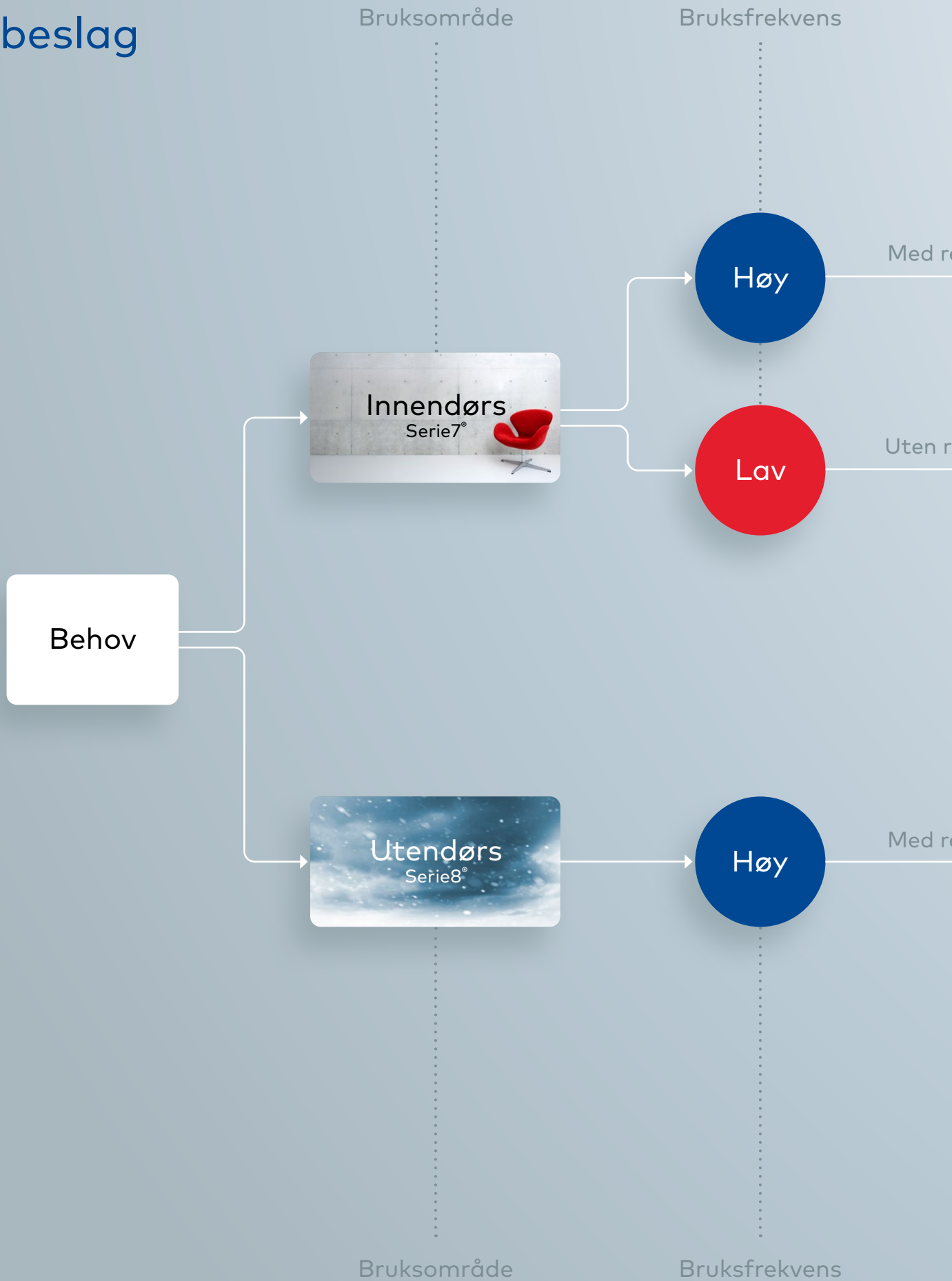

Design/Stil

Overflate

Serie7®



Samme design



Design/Stil

Overflate

eturfjær

eturfjær

eturfjær

Serie8®

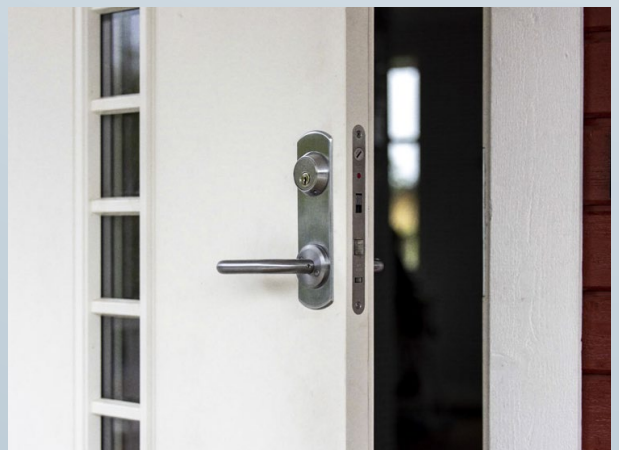
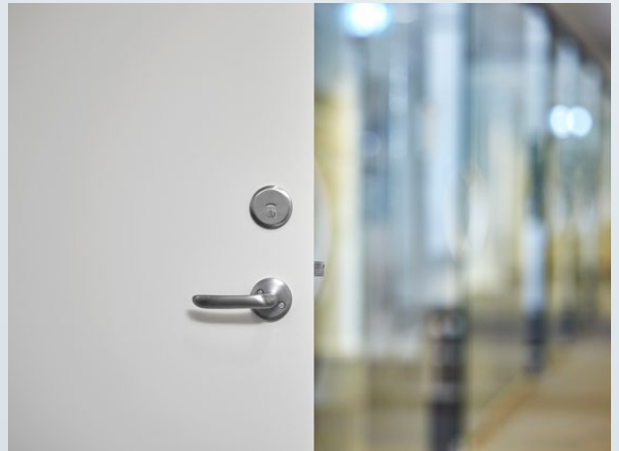

dormakaba Norge AS

Tlf.: 06866

firmapost.no@dormakaba.com

www.dormakaba.no